



# Distribution System

## Wide Range-Varied Applications



- User Friendly
- Durable
- Elegant
- Economical
- Sleek Design
- Money Saver

## Design

HPL Distribution Systems in Sheet Steel Enclosures are Fabricated with utmost precision. Compact designs have been developed to ensure convenience and ease of installation and operation. They favourably match with the National & International technology.

## Construction

The enclosures are fabricated out of best quality CRCA steel sheet for better strength and finish. The distribution systems are supplied duly fitted with Din channel, neutral link earth bar and bus bar, so that the MCB's of desired number and ratings can be fitted conveniently at site, except for one to four pole enclosures, which are only fitted with Din Channel.

## Millennium - SP & N Distribution System

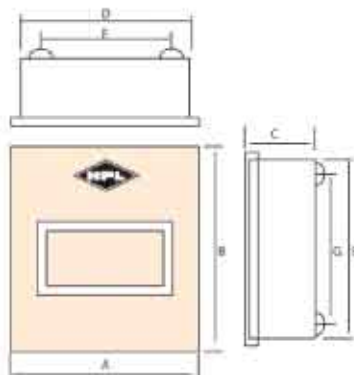

## Powder Paint

High quality powder coated and baked at high temperature. Before powder coating the housing go through rigorous anti - rust conditioning in seven tank processes to ensure smooth and lasting finish and protection against corrosive atmosphere.

HPL Elegant Distribution Systems are designed with the best combination of engineering technology and aesthetic to suit various applications.

Single Phase and Neutral Sheet Steel Powder Coated Distribution System, with cream colour frame and Poly Carbonate transparent cover for protection of MCB's, fitted with Bus Bar, Neutral link, Earth Bar and Din Rail. Suitable for use on 240/415V, 50Hz Supply.

Ways	Cat. No.	To Accommodate
06	DBSMD06	06 Nos. SP MCB
10	DBSMD10	10 Nos. SP MCB
12	DBSMD12	12 Nos. SP MCB
16	DBSMD16	16 Nos. SP MCB

## Dimension Details

Ways	A	B	C	D	E	F	G
06	214	224	86	200	210	150	160
10	284	224	86	270	210	220	160
12	320	224	86	305	210	255	160
16	390	224	86	375	210	325	160

## Single Door SP & N Distribution System

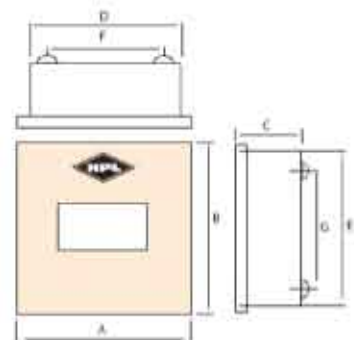

Single Phase and Neutral Sheet Steel Powder Coated Distribution System for MCB, fitted with Bus Bar, Neutral Link, Earth Bar and Din Rail. Suitable for use on 240/415V, 50Hz Supply.

Ways	Cat. No.	To Accommodate
04	DBSD04	04 Nos. SP MCB
06	DBSD06	06 Nos. SP MCB
08	DBSD08	08 Nos. SP MCB
12	DBSD12	12 Nos. SP MCB
16	DBSD16	16 Nos. SP MCB

## Dimension Details

Ways	A	B	C	D	E	F	G
04	154	224	63	140	210	90	160
06	189	224	63	175	210	125	160
08	224	224	63	210	210	160	160
12	294	224	63	280	210	230	160
16	364	224	63	350	210	300	160

### Single Door TP & N Distribution System

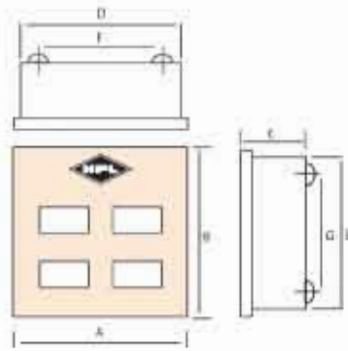

Three Phase & Neutral Sheet Steel Powder Coated Distribution System, fitted with Bus Bar, Neutral link, Earth Bar and Din Rail. Suitable for use on 240/415V, 50Hz Supply.

Ways	Cat. No.	To Accommodate
04	DBTSD04	12 Nos. SP MCB
06	DBTSD06	18 Nos. SP MCB
08	DBTSD08	24 Nos. SP MCB
12	DBTSD12	36 Nos. SP MCB

#### Dimension Details

Ways	A	B	C	D	E	F	G
04	309	459	86	295	445	225	375
06	344	459	86	330	445	260	375
08	414	459	86	400	445	330	375
12	554	459	86	540	445	470	375

### Versatile Double Door SP & N Distribution System

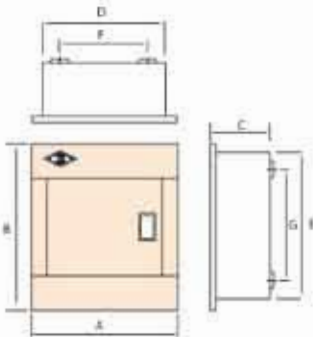

Single Phase and Neutral Sheet Steel Powder Coated Double Door Distribution System, fitted with two cover, one screwed cover for incoming and out going for MCB and second for protection of MCB's, fitted with Bus Bar, Neutral Link, Earth Bar and Din Rail. Suitable for use on 240/415v, 50Hz Supply.

Ways	Cat. No.	To Accommodate
04	DBDD04	04 Nos. SP MCB
06	DBDD06	06 Nos. SP MCB
08	DBDD08	08 Nos. SP MCB
12	DBDD12	12 Nos. SP MCB
16	DBDD16	16 Nos. SP MCB

#### Dimension Details

Ways	A	B	C	D	E	F	G
04	170	240	86	140	210	90	160
06	205	240	86	175	210	125	160
08	240	240	86	210	210	160	160
12	310	240	86	280	210	230	160
16	380	240	86	350	210	300	160

### Versatile Double Door TP & N Distribution System



Three Phase and Neutral Sheet Steel Powder Coated Double Door Distribution System, fitted with two cover, one screwed cover for incoming and outgoing MCB's and second for protection of MCB's fitted with Bus Bar neutral link Earth Bar and Din Rail. Suitable for use on 240/415V, 50Hz Supply.

Ways	Cat. No.	To Accommodate
04	DBTDD04	12 Nos. SP MCB
06	DBTDD06	18 Nos. SP MCB
08	DBTDD08	24 Nos. SP MCB
12	DBTDD12	36 Nos. SP MCB

#### Dimension Details

Ways	A	B	C	D	E	F	G
04	320	475	86	295	445	225	375
06	360	475	86	330	445	260	375
08	430	475	86	400	445	330	375
12	570	475	86	540	445	470	375

### Consumer Unit SP & N Distribution System

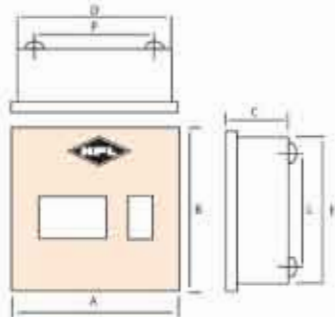

Single Phase and Neutral Sheet Steel Powder Coated Distribution System, fitted with 40/63A, DP Isolator or ELCB as incomer fitted with Bus Bar, Neutral link, Earth Bar and Din Rail. Suitable for use on 240/415V, 50Hz Supply.

Ways	Cat. No.	To Accommodate
04	DBCUS04	04 Nos. SP MCB
06	DBCUS06	06 Nos. SP MCB
08	DBCUS08	08 Nos. SP MCB
10	DBCUS10	10 Nos. SP MCB
12	DBCUS12	12 Nos. SP MCB

#### Dimension Details

Ways	A	B	C	D	E	F	G
04	224	224	63	210	210	160	160
06	259	224	63	245	210	195	160
08	294	224	63	280	210	230	160
10	329	224	63	315	210	265	160
12	364	224	63	350	210	300	160

### Consumer Unit with Polycarbonate Cover

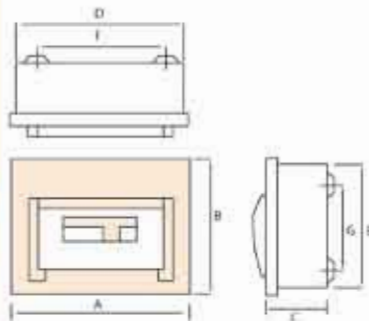

Single Phase and Neutral Sheet Steel Powder Coated Distribution System with Poly Carbonate transparent cover for protection of MCB's, fitted with 40/63A DP Isolator or ELCB as incomer and fitted with Bus Bar, Neutral Link, Earth Bar and Din Rail. Suitable for use on 240/415V, 50Hz Supply.

Ways	Cat. No.	To Accommodate
04	DBCUSP04	04 Nos. SP MCB
06	DBCUSP06	06 Nos. SP MCB
08	DBCUSP08	08 Nos. SP MCB
10	DBCUSP10	10 Nos. SP MCB
12	DBCUSP12	12 Nos. SP MCB

#### Dimension Details

Ways	A	B	C	D	E	F	G
04	224	224	63	210	210	160	160
06	259	224	63	245	210	195	160
08	294	224	63	280	210	230	160
10	329	224	63	315	210	265	160
12	364	224	63	350	210	300	160

### Consumer Unit TP & N Distribution System

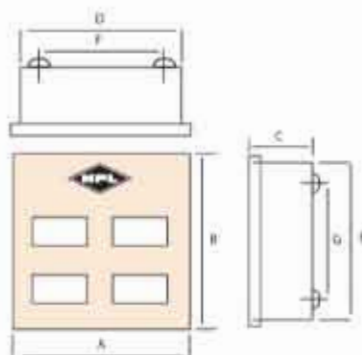

Three Phase and Neutral Sheet Steel Powder Coated Distribution System fitted with 4Pole Isolator or ELCB as incomer and fitted with Bus Bar, Neutral Link, Earth Bar and Din Rail. Suitable for use on 240/415V, 50Hz Supply.

Ways	Cat. No.	To Accommodate
04	DBCUTI4	12 Nos. SP MCB
06	DBCUTI6	18 Nos. SP MCB
08	DBCUTI8	24 Nos. SP MCB

#### Dimension Details

Ways	A	B	C	D	E	F	G
04	309	459	86	295	445	225	375
06	344	459	86	330	445	260	375
08	414	459	86	400	445	330	375

### Vertical Single Door TP & N Distribution System

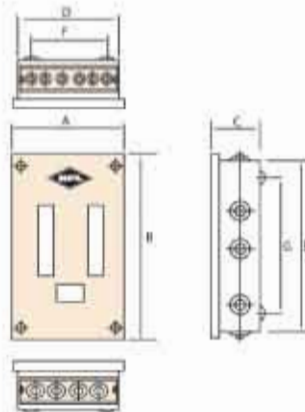

Three Phase and Neutral Sheet Steel Powder Coated Distribution System for single/multi phase out going fitted with Colour coated Bus Bar, Neutral Link, Earth Bar and Din Rail. Suitable for use on 240/415V, 50Hz Supply.

Ways	Cat. No.	To Accommodate
04	DBVSD04	12 Nos. SP MCB or 04 Nos. TP MCB
08	DBVSD08	24 Nos. SP MCB or 08 Nos. TP MCB
12	DBVSD12	36 Nos. SP MCB or 12 Nos. TP MCB

#### Dimension Details

Ways	A	B	C	D	E	F	G
04	384	459	88	370	445	300	375
08	384	564	88	370	550	300	480
12	384	669	88	370	655	300	585

### Vertical Double Door TP & N Distribution System Fitted with 63 Amps FP Isolator

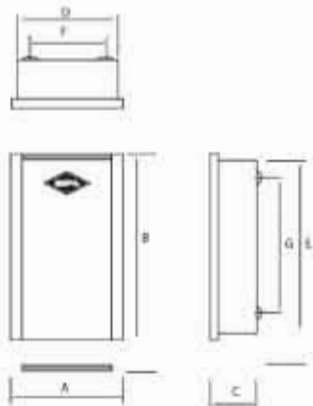

Three Phase & Neutral Sheet Steel Powder Coated Double Door Vertical Distribution System, fitted with two cover one screwed cover for incoming and outgoing MCB's and the second for protection of MCB's fitted with Colour coated Bus Bar, Neutral link, Earth Bar & Din Rail. Suitable for use on 240/415V, 50Hz Supply.

Ways	Cat. No.	To Accommodate
04	DBVDD04	12 Nos. SP MCB or 04 Nos. TP MCB
08	DBVDD08	24 Nos. SP MCB or 08 Nos. TP MCB
12	DBVDD12	36 Nos. SP MCB or 12 Nos. TP MCB

#### Dimension Details with Isolator as incomer

Ways	A	B	C	D	E	F	G
04	395	470	110	370	445	300	375
08	395	575	110	370	550	300	480
12	395	680	110	370	655	300	585

### Vertical Double Door TP & N Distribution System Suitable for MCCB as Incomer

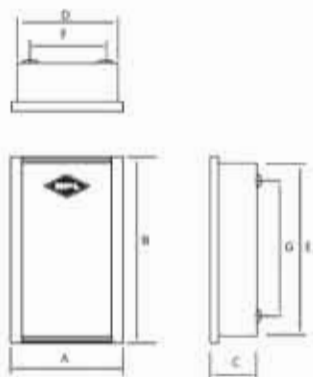

Three Phase & Neutral Sheet Steel Powder Coated Double Door Vertical Distribution System, fitted with two cover one screwed cover for incoming and outgoing MCB's and the second for protection of MCB's fitted with Colour coated Bus Bar, Neutral link, Earth Bar & Din Rail. Suitable for use on 240/415V, 50Hz Supply.

Ways	Cat. No.	To Accommodate
04	DBVDD04-MCCB	12 Nos. SP MCB or 04 Nos. TP MCB
08	DBVDD08-MCCB	24 Nos. SP MCB or 08 Nos. TP MCB
12	DBVDD12-MCCB	36 Nos. SP MCB or 12 Nos. TP MCB

#### Dimension Details with MCCB as incomer

Ways	A	B	C	D	E	F	G
04	395	520	110	370	495	300	425
08	395	625	110	370	600	300	530
12	395	730	110	370	705	300	635

### Phase Selector Distribution System

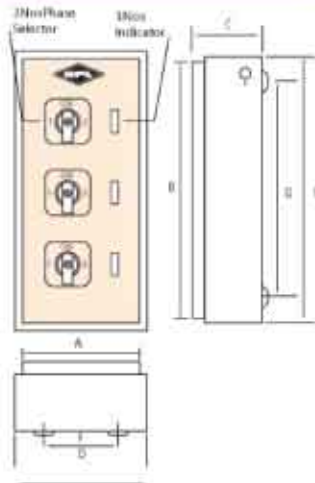

Phase Selector Distribution Board in Sheet Steel Enclosure, Powder Coated has 3Nos HPL-Elektra selector switches with indicating lights. Suitable for use on 240/415V, 50Hz Supply.

#### Dimension Details

Amps	A	B	C	D	E	F	G
40	165	375	80	170	380	100	310
63	165	375	80	170	380	100	310

Discription	Cat. No.
40A. IP + 3W + Off	HPsDB40913
63A. IP + 3W + Off	HPsDB63913

### Phase Selector Single Door - Distribution System

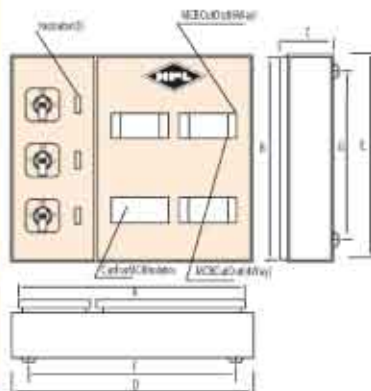

Phase Selector Distribution System in Sheet Steel Enclosure, Powder Coated has two separate compartments, one fitted with 3Nos. HPL-Elektra selector switches with indicating lights duly wired and other one for outgoing MCB's and also provision for 4 pole ELCB/MCB/Isolator, fitted with Bus Bar, Neutral Link, Earth Bar and DIN Rail. Suitable for use on 240/415V, 50Hz Supply.

Ways	Cat. No.	To Accommodate
04	PSDBSD440	12 Nos. SP MCB
06	PSDBSD663	18 Nos. SP MCB
08	PSDBSD863	24 Nos. SP MCB

#### Dimension Details

Ways	Amp.	A	B	C	D	E	F	G
4	40	445	375	100	450	380	380	310
6	63	445	375	100	450	380	380	310
8	63	515	375	100	520	380	450	310

### Plug - SP & TP

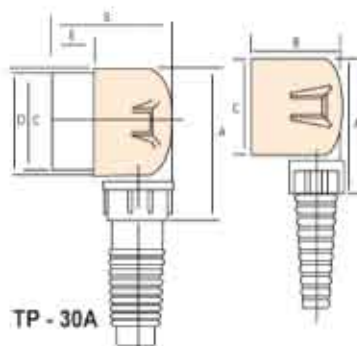

Plug in Aluminium Die-cast body fitted with brass pins with Protection Sleeve for connecting leads. Suitable for use on 240/415V, 50Hz Supply.

#### Dimension Details

Type	Rating	A	B	C	D	E	F	G
SP	10Amp	56	36	39	-	-	-	-
	20Amp	67	43	47	-	-	-	-
TP	20Amp	72	43	52	-	-	67	5
	30Amp	92	92	63	66	26	75	5

### Phase Selector Double Door - Distribution System

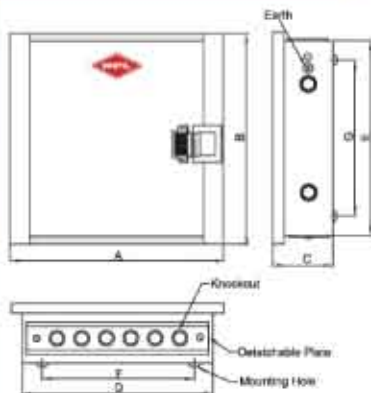

Double door Phase Selector Distribution System in Sheet Steel Enclosure, Powder Coated, fitted with Bus Bar, Neutral Link, Earth Bar. DB consists of 3Nos. HPL-Elektra selector switches with/without 63A, Three pole Isolators and indicating lights duly wired suitable for use on 240/415V, 50Hz Supply.

Ways	Cat. No.	To Accommodate
04	PSDBDD440	12 Nos. SP MCB
06	PSDBDD663	18 Nos. SP MCB
08	PSDBDD863	24 Nos. SP MCB

#### Dimension Details

Ways	Amp	A	B	C	D	E	F	G
04	40	502	540	138	482	520	412	450
06	63	502	540	138	482	520	412	450
08	63	607	540	138	587	520	517	450

### Plug & Socket Distribution Board

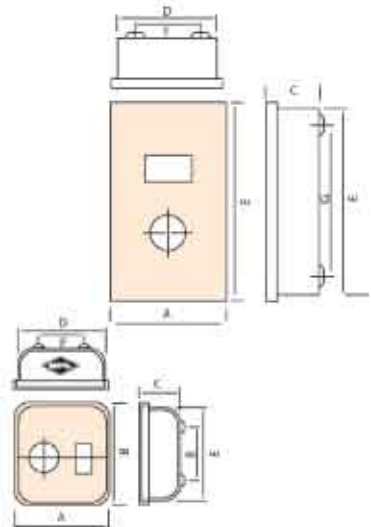

Metal Clad Plug & Socket Distribution Board fitted with DIN channel and Indication light. Suitable for use on 240/415V, 50Hz Supply.

Type	Fitted with	Cat. No.	Rating	To Accommodate
SP	2Pin P & S	DBSP10	10A	10A SP MCB
	2Pin P & S	DBSP20	20A	20A SP MCB
TP	3Pin P & S	DBTP20	20A	20A TP MCB
	3Pin P & S	DBTP30	30A	32A TP MCB

#### Dimension Details

Type	Amp	A	B	C	D	E	F	DIA
SP	10	136	164	63	124	150	80	105
	20	136	164	63	124	150	80	105
TP	20	130	290	63	115	275	65	225
	30	130	290	63	115	275	65	225

### Socket - SP and TP

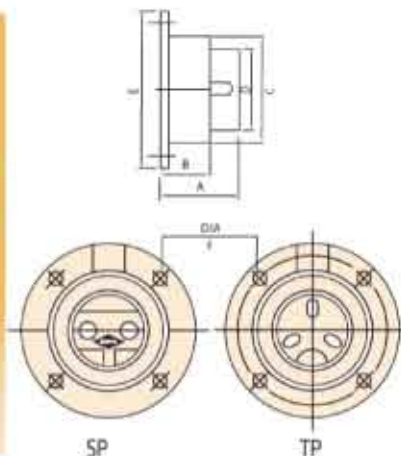

Socket in Aluminium Die-cast body fitted with DMC/Porcelain base. Suitable for use on 240/415V, 50Hz Supply.

#### Dimension Details

Type	Amp	A	B	C	D	E	F	DIA
SP	10	27	15	44	35	57	36	5
	20	38	25	53	41	68	43	5
TP	20	42	26	62	47	75	48	5
	30	55	33	69	57	84	54	5



### MCB Cut Out Plastic



Industrial Plastic Moulded Cut Out for MCB's. Suitable for use on 240/415V, 50Hz Supply.

Ways	Cat. No.	To Accommodate
1/2 Pole	DBPE02	1 or 2 Nos. SP MCB
3/4 Pole	DBPE04	3 or 4 Nos. SP MCB

#### Dimension Details

Ways	A	B	C	D	E
1/2 Pole	52	131	60	36	113
3/4 Pole	87	131	60	71	113

### MCB Cut Out Sheet Metal

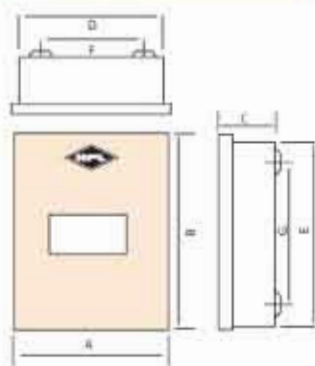

Sheet Steel Cut Out for MCB's. Suitable for use on 240/415V, 50Hz Supply.

Ways	Cat. No.	To Accommodate
1/2 Pole	DBSS01/02	1 or 2 Nos. SP MCB
3/4 Pole	DBSS03/04	3 or 4 Nos. SP MCB

#### Dimension Details

Ways	A	B	C	D	E	F	G
1/2 Pole	85	155	63	75	145	35	105
3/4 Pole	115	155	63	105	145	65	105

#### Note :

All DB's are available with/without Miniature Circuit Breakers. Fit Rakshak (6 ka) or Techno (10 ka) mid - trip as per your choice and requirement.



## HAVELL'S ELECTRONICS PVT. LTD.

1/21, Asaf Ali Road, New Delhi - 110 002 Phones : 23234411, 23236811

Fax : 91-11-23232639 E-mail : hpl@hplindia.com

[www.hplindia.com](http://www.hplindia.com)

#### Branch Offices :

- Ahmedabad Ph.: 079-26580203
- Bangalore Ph.: 080-22863069
- Cochin Ph.: 0484-2354595
- Chennai Ph.: 044-24341141
- Vapi
- Jammu
- Kolkata Ph.: 033-22116629
- Kanpur Ph.: 0512-2353743
- Mumbai Ph.: 022-25092746
- Pune Ph.: 020-25672928
- Secunderabad Ph.: 040-55687878
- Chandigarh Ph.: 0172-2577815
- Jaipur Ph.: 0141-5106268
- Vadodara Ph.: 0265-2352107
- Ludhiana
- Lucknow
- Raipur
- Madurai
- Patiala
- Vizag
- Bhubaneshwar
- Calicut
- Trivandrum
- Bhopal
- Udaipur
- Indore
- Surat
- Nagpur
- Guwahati
- Palakhat

Due to continuous development, specifications and features are subject to change without prior notice.